

# D64

## 1MP Indoor Dome with D/N, IR, Vari-focal lens



- Progressive Scan CMOS
- Day and night function with mechanical IR cut filter
- Minimum illumination 0 lux with IR LED on
- Built-in f2.8~12mm / F1.4 Megapixel vari-focal lens
- 30 fps at 1280 x 720 resolution
- Selectable H.264 HP, MJPEG compressions with dual streaming
- Video motion detection
- MicroSDHC card slot for local storage
- Vandal Resistant IK09 rated casing
- Powered by PoE Class 2

### PHOTO INDICATION

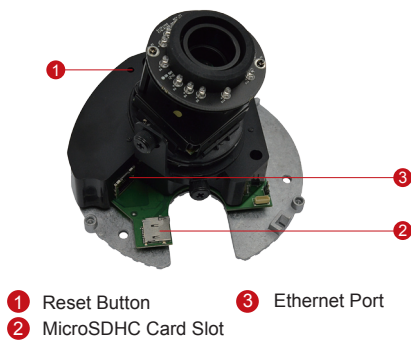

- 1 Reset Button
- 2 MicroSDHC Card Slot
- 3 Ethernet Port



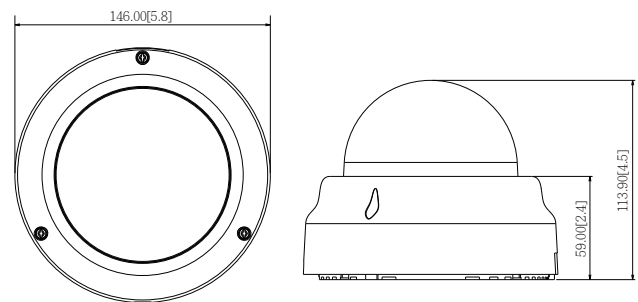



### DIMENSION DIAGRAM



Unit: mm [inch]

### ACCESSORY OPTIONS

Dome Cover		
PDCX-1101		4-inch, smoke, vandal proof

Popular Mounting Solutions	
Surface	Accessories not required
Wall	PMAX-0308 
Pendant	PMAX-0101 + PMAX-0103 
Corner	PMAX-0101 + PMAX-0303 + PMAX-0402 
Pole	PMAX-0101 + PMAX-0303 + PMAX-0503 
Flush	PMAX-1003 
Gang Box	PMAX-0803 

\* For more mounting solutions, please refer to Project Planner on [www.acti.com](http://www.acti.com)

**PRODUCT SPECIFICATION****D64****• Device**

Device Type	Indoor Dome Camera
Image Sensor	Progressive Scan CMOS
Sensor Size	1/4"
Day / Night	Yes
Minimum Illumination	Color: 0.1 lux at F1.4 (30 IRE, 2400°K); B/W: 0 lux (IR LED on)
Color to B/W switch	ISP based switch, configurable
Mechanical IR Cut Filter	Yes
IR Sensitivity Range	700~1100nm
IR LED	IR LED x 15 (850nm)
IR Working Distance	15 m (0 lux, 30 IRE, Max exposure gain)
Electronic Shutter	1/5 ~ 1/2,000 sec (manual mode); 1/5 ~ 1/10,000 sec (auto mode)

**• Lens**

Focal Length / Aperture	Vari-focal, f2.8 - 12 mm / F1.4
Iris	Fixed iris
Focus	Manual focus
Mount Type	Board Mount
Horizontal Viewing Angle	59.8° - 24.7°
Viewing Angle Adjustment	Pan: 0° - 350°; Tilt: 17° - 163°; Rotate: 0° - 350°

**• Video**

Compression	H.264 HP, MJPEG
Maximum Frame Rate vs. Resolution	30 fps at 1280 x 720; 30 fps at 640 x 480
Multi-Streaming	Simultaneous dual streams based on two configurations
Bit Rate	28 Kbps - 6 Mbps (per stream)
Bit Rate Mode	Constant, Variable
Image Enhancement	White balance: automatic, hold, and manual; Brightness; Contrast; Sharpness(auto); Auto gain control; Digital noise reduction; Flickerless
Privacy Mask	4 configurable regions
Text Overlay	User defined text on video
Image Orientation	Image flip and mirror

**• Network**

Protocol & Service	TCP, UDP, HTTP, HTTPS, DHCP, PPPoE, RTP, RTSP, IPv6, DNS, DDNS, NTP, ICMP, ARP, IGMP, SMTP, FTP, UPnP, SNMP, Bonjour
Ethernet Port	1, Ethernet (10/100 Base-T), RJ-45 connector
Security	IP address filtering; HTTPs encryption; Password protected user levels; Anonymous login; IEEE802.1X network access control

**• Alarm**

Alarm Trigger	Video motion detection (3 regions)
Alarm Response	Notify control center; Change camera settings; Command other devices; E-mail notification with snapshots; Save video or snapshot to local storage; Upload video, snapshot to FTP

**• Interface**

Local Storage	MicroSDHC memory card slot (card not included)
---------------	--

**• General**

Power Source / Consumption	PoE Class 2 (IEEE802.3af) / 4.22 W (IR on)
Weight	503 g (1.11 lb)
Dimensions (Ø x H)	146 mm x 113.9 mm (5.8" x 4.5")
Environmental Casing	Vandal Resistant (IK09 rated); Transparent dome cover
Mount Type	Surface, Pendant, Wall, Corner, Pole, Flush, Gang Box
Starting Temperature	-10°C ~ 50°C (14°F ~ 122°F)
Operating Temperature	-10°C ~ 50°C (14°F ~ 122°F)
Operating Humidity	10% ~ 85% RH
Approvals	CE (EN 55022 Class B, EN 55024), FCC (Part15 Subpart B Class B), IK09

**• Integration**

Unified Solution	Fully compatible with ACTi software
ISV Integration	Software Development Kit (SDK) available; ONVIF compliant
Firmware Access Browser	Microsoft Internet Explorer 8.0 or newer (full functionality); Other browsers with VLC installed (partial functionality)

\* All specifications are subject to change without notice.

\* All brand names and registered trademarks are the property of their respective owners.

[www.acti.com](http://www.acti.com)